

REV.	DESCRIPTION	DATE
—	RELEASE	Oct. 21, 2002
1	SHELL PLATING MODIFY	Jan. 17, 2003
2	DRAW MODIFY	Feb. 10, 2003
3	DRAW MODIFY	Apr. 23, 2003
4	P/N MODIFY	Jul. 11, 2003
5	DRAW MODIFY	Aug. 02, 2003

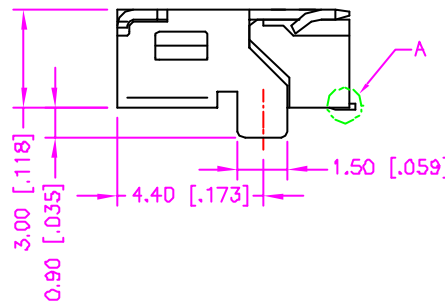
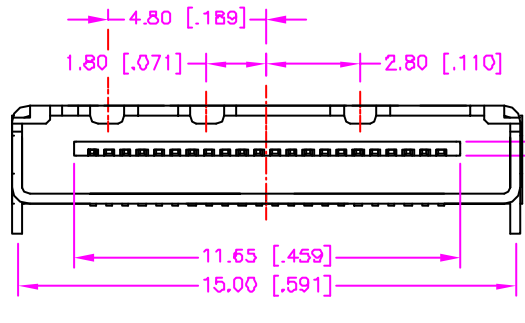
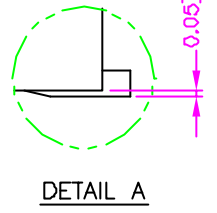
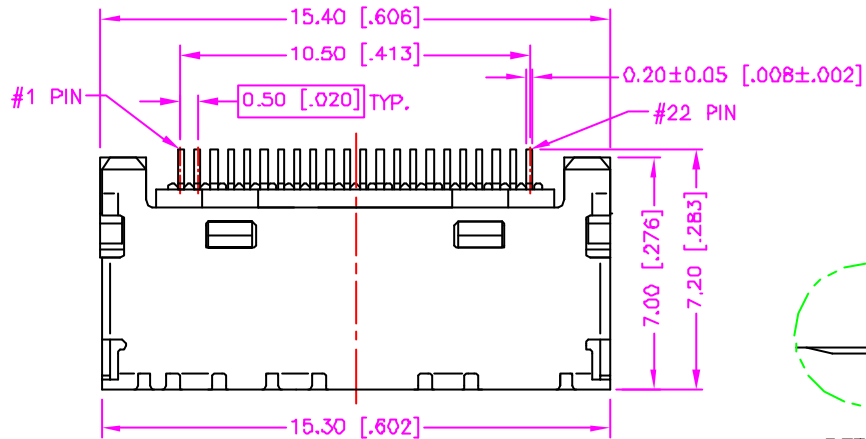

MATERIALS

- HOUSING : HI.-TEMP. PLASTIC (UL 94V-0), BLACK.
- TERMINAL : COPPER ALLOY, GOLD PLATING.
($t=0.20\text{mm}$)
- SHELL : STAINLESS STEEL, NICKEL PLATING.
($t=0.30\text{mm}$)

SPECIFICATION

- CURRENT RATING : 1 AMP. MAX.
- DIELECTRIC WITHSTANDING VOLTAGE :
250V AC R.M.S. FOR ONE MINUTE.
- INSULATION RESISTANCE : 1000M OHMS MIN.
AT 250V DC.
- OPERATING TEMPERATURE : -40°C TO $+85^{\circ}\text{C}$.
- MAX. PROCESSING TEMP. :
 230°C FOR 30 ~ 60 SECONDS.

ORDER INFORMATION :

6191022-00*

PACKAGE OPTIONS
1: TAPE PACKAGE
5: TRAY PACKAGE

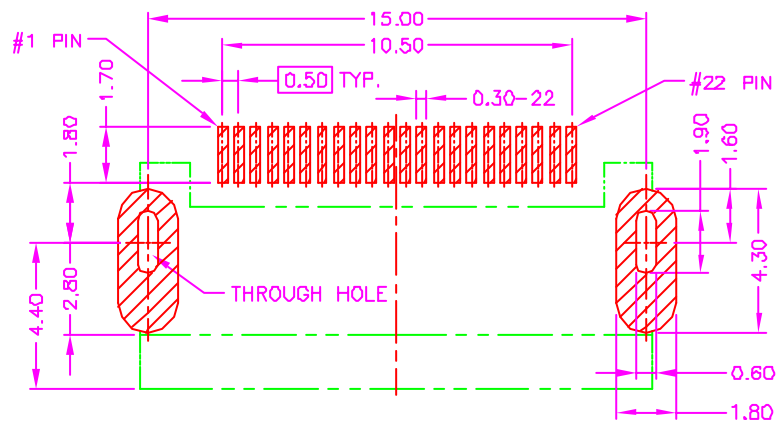

RECOMMEND P.C.B. LAYOUT
TOP VIEW

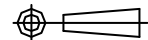
TOLERANCE .0 = ± 0.38 [0.015] .00 = ± 0.25 [0.010] .000 = $\pm .xxx$.0000 = \pm ANG. = $\pm 3^{\circ}$		DRAWER <i>Katherine</i>	 ASTRON TECHNOLOGY CORP.
CHECK <i>MUS</i>		APP'D <i>LTON</i>	
 UNITS : mm [inch]		PRODUCT SPEC.	NAME MOBILE PHONE CONNECTOR P.C.B. MOUNT SMT, MALE 0.50mm PITCH, 22 PINS TYPE I, (A TYPE)
SCALE NONE	SIZE A4	SHEET 1 OF 1	REV. F
		DRAW NO. C797-1112	10018